

Ansicht 1 / 3D

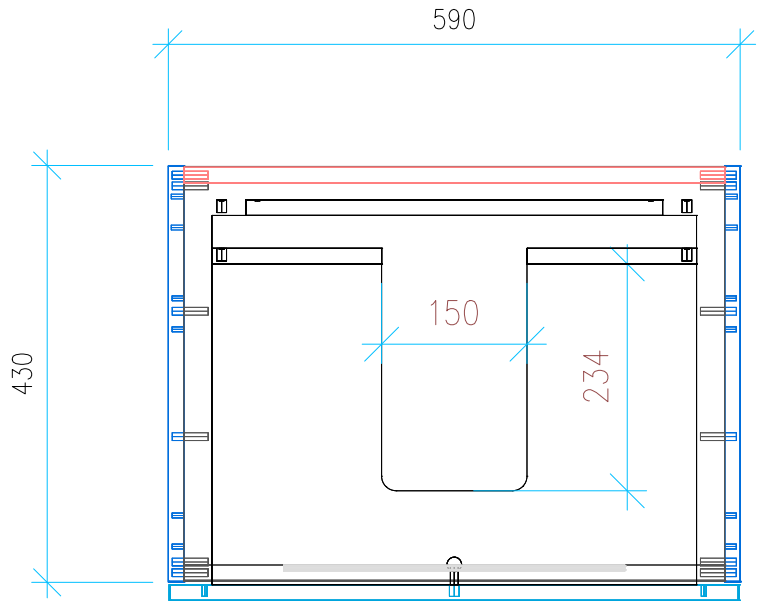

Ansicht 2 / Draufsicht

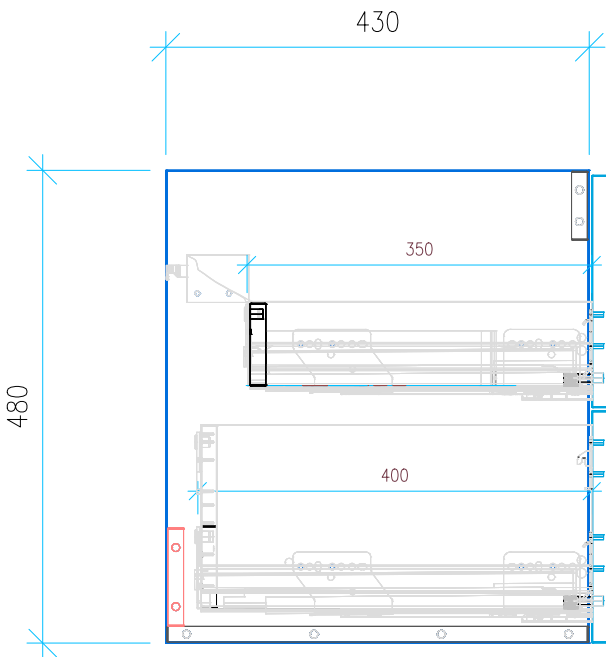

Ansicht 3 / Seitenansicht Links

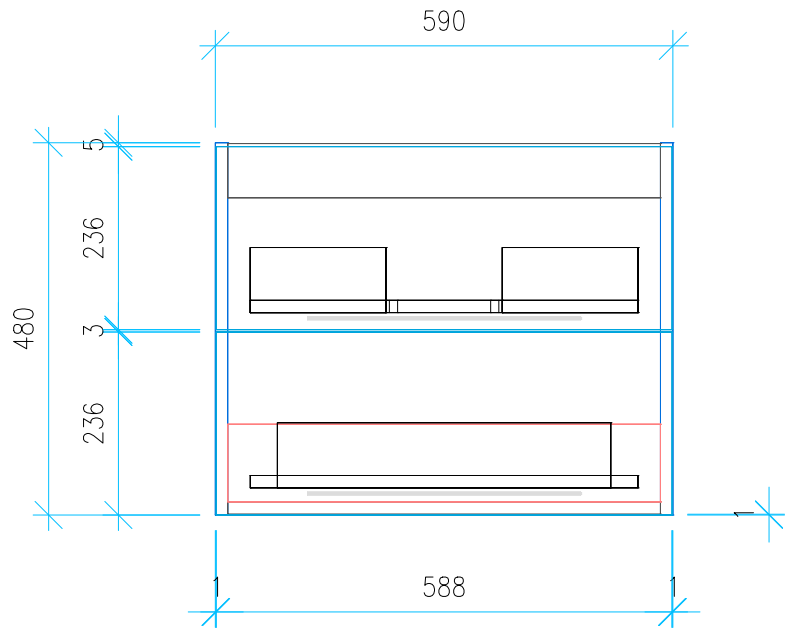

Ansicht 4 / Vorderansicht

Höhe 480 Breite 590 Tiefe 430	Erstellt 11.07.2024	Artikelname
	Maße in mm	WTU_SCA_TEOR2_0_60_SLV_PTO
	Gewicht in kg	